

Uniden®

OWNER'S MANUAL

TRU3455



24.4GHZ
DIGITAL SPREAD SPECTRUM

Welcome

Congratulations on your purchase of the Uniden TRU3455 cordless telephone. This phone is designed and engineered to exacting standards for reliability, long life and outstanding performance.

Note: Some illustrations in this manual may differ from the actual unit for explanation purposes.

Features

- 2.4 GHz Digital Spread Spectrum
- Integrated Answering Device
- 35 Channel Autoscan
- 20-Number Memory Dialing (10 on the handset and 10 on the base)
- Tone/Pulse Dialing
- Handset Volume Control
- 32 Digit Redial
- Dual keypad Operation
- Page/Intercom
- AutoTalk™
- AutoStandby™
- 6 Hour Talk Time
- 10 Day Standby Time
- Hearing Aid Compatible

The TRU3455 features include **AutoTalk™** and **AutoStandby™**. AutoTalk allows you to answer a call by just removing the handset from the base so you don't have to waste time pushing buttons or flipping switches. AutoStandby allows you to hang up by simply returning the handset to the base.

To protect you against misbilled calls which might result from your phone being activated by other equipment, the TRU3455 has **Random Code™** digital security which automatically selects one of over 65,000 digital security codes for the handset and base. Also, the **AutoSecure™** feature electronically locks your phone when the handset is in the base.

Be sure to visit our web site: www.uniden.com

Uniden® is a registered trademark of Uniden America Corporation.

AutoTalk, AutoStandby, Random Code, and AutoSecure are trademarks of Uniden America Corporation.



Contents

Welcome/Features			
Controls and Functions	2, 3		
Getting Started			
Read this first	4		
Checking the Package Contents	5		
Setting up the Phone	6		
Basics			
Making and Receiving Calls	11		
Terminology	12		
Adjusting Ringer/Volume Controls	12		
Tone Dialing Switch-over	13		
Traveling Out-of-Range	13		
Selecting a Different Channel	14		
Using the Flash Button	14		
3-way Conferencing	15		
Intercom Feature	16		
Call Transfer Feature	17		
Memory Dialing			
Storing a Number in Memory	18		
Entering a Pause in Memory Dialing	19		
		Storing Mixed Tone/Pulse Numbers	19
		Dialing a Stored Number	20
		Chain Dialing	20
		Erasing a Stored Number	21
		Mute	21
		Replacing a Stored Number	21
		The Integrated Answering Device	
		Features	22
		Setting Up Your Answering System	23
		Using Your Answering System	26
		Additional Information	
		Changing the Digital Security Code	31
		Installing the Beltclip	32
		Headset Installation	32
		Note on Power Sources	33
		Maintenance	33
		Troubleshooting	34
		General Information	36
		Precautions	37
		Warranty	38
		Index	39

Controls and Functions

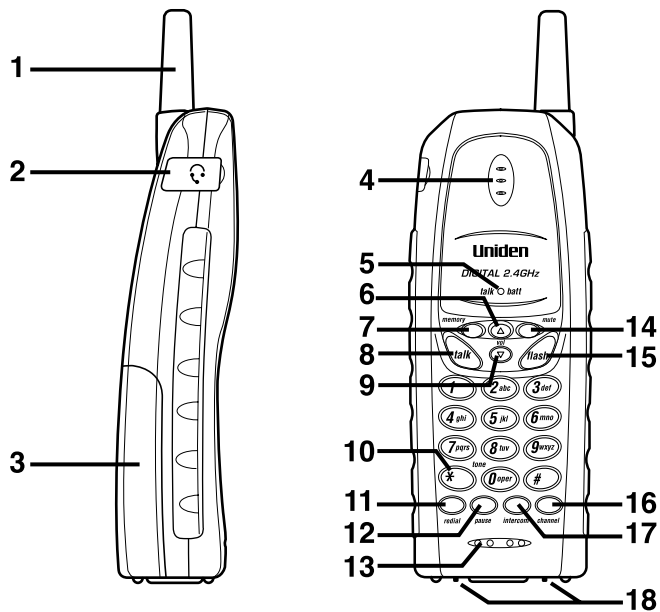

1. Handset Antenna
2. Headset Jack Cover
3. Handset Battery Compartment
4. Handset Earpiece
5. Talk/Batt (Talk/Battery) LED
6. Vol (Volume)/Cursor up ▲ Key
7. Memory Key
8. Talk Key
9. Vol (Volume)/Cursor down ▼ Key
10. */tone Key
11. Redial Key
12. Pause Key
13. Handset Microphone
14. Mute Key
15. Flash Key
16. Channel Key
17. Intercom Key
18. Handset Charging Contacts

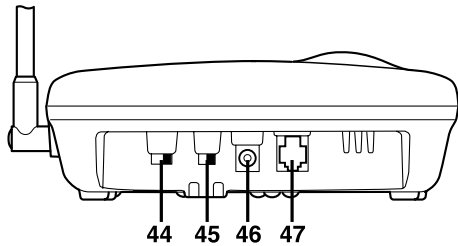
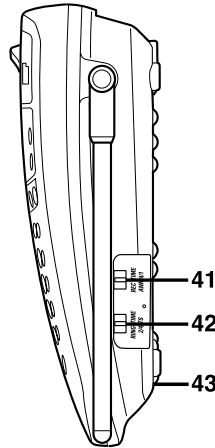
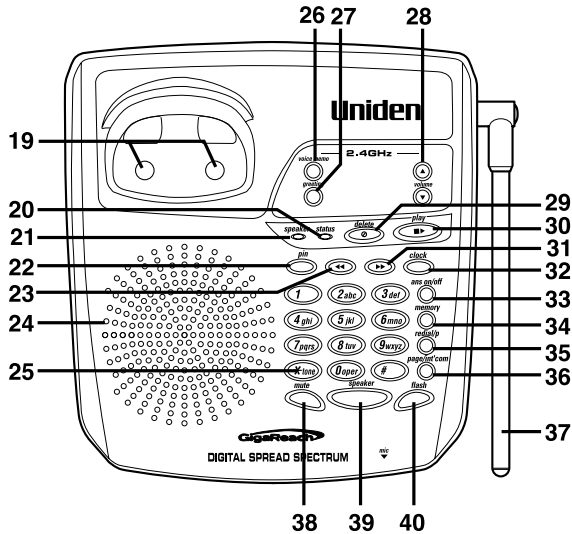

- 27. Greeting Key
- 28. Base Speaker Volume Adjust
- 29. Delete Key
- 30. Play Key
- 31. Forward Key
- 32. Clock Key
- 33. Ans on/off (Answer on/off) Key
- 34. Memory Key
- 35. Redial/P (Redial/Pause) Key
- 36. Page/int`com (Page/Intercom) Key
- 37. Base Antenna
- 38. Mute Key
- 39. Speaker Key
- 40. Flash Key
- 41. Record Time Switch
- 42. Ring Time Switch
- 43. Base Microphone
- 44. Base Ringer Switch
- 45. Pulse-Tone Switch
- 46. DC Power Input
- 47. Phone Jack

- 19. Base Charging Contacts
- 20. Status LED
- 21. Speaker LED
- 22. PIN Key
- 23. Reverse Key
- 24. Base Speaker
- 25. */Tone Key
- 26. Voice Memo Key

Read This First

This cordless telephone must be set up before use. Follow these steps:

Step 1 (page 5)

Unpack the telephone and accessories.

Step 2 (page 6)

Next, choose the best location to set up the base unit.



Step 3 (page 7 to 10)

Then, insert the battery pack into the handset. Connect the base unit. You must charge the battery pack for **15-20 hours before plugging into the telephone line and using the phone.**

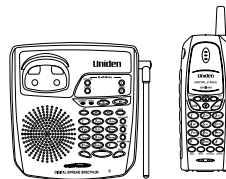

About the digital security code

This cordless telephone uses a digital security code to prevent unauthorized access to your base unit. This security code prevents other cordless handsets from making calls through your base unit.

A random security code will be assigned automatically between your base unit and handset when you charge the battery pack for the first time.

If you want to reset the security code, see page 31.

Checking the Package Contents

Make sure you have received the following items in the package. If any of these items are missing or damaged, contact the Uniden Parts Department (see below).

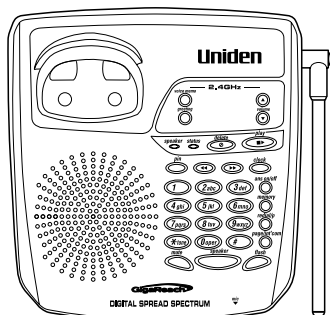

• Base unit



• Handset

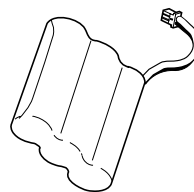

• Rechargeable battery
(BT-800)

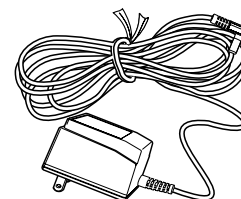

• AC adapter
(AD-313)



• Beltclip

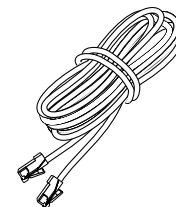

• Telephone cord

Also included:

- This Owner's Manual
- Quick Reference Guide

Uniden Parts Department at (800) 554-3988
Hours: M-F 7:00 a.m. to 5:00 p.m. CST.
We can also be reached on the web at www.uniden.com

Setting up the Phone

Do the following steps:

- A. Choose the best location
- B. Install the battery pack
- C. Connect the base unit
- D. Choose the dialing mode

A. Choose the best location

Before choosing a location for your new phone, read the **INSTALLATION CONSIDERATIONS** included in the **PRECAUTIONS AND IMPORTANT SAFETY INSTRUCTIONS** brochure. Here are some important guidelines you should consider:

Avoid heat sources, such as radiators, air ducts, and sunlight

Avoid television sets and other electronic equipment

Avoid noise sources such as a window by a street with heavy traffic

Avoid microwave ovens

Avoid excessive moisture, extremely low temperatures, dust, mechanical vibration, or shock

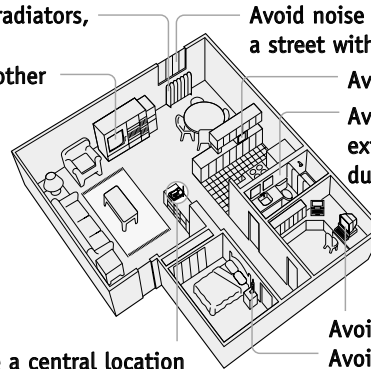

Choose a central location

Avoid personal computers

Avoid other cordless telephones

- The location should be close to both a phone jack and a continuous power outlet which is not switchable.
- Keep the base and handset away from sources of electrical noise such as motors, microwave ovens, and fluorescent lighting.
- Be sure there is sufficient space to raise the base antenna to a vertical position.
- The base can be placed on a desk, tabletop, or mounted on a standard wall plate.
- If your second phone line has a separate modular jack, place your phone so you can access both jacks.

 note

Use only the Uniden Battery (BT-800) supplied with your phone. Replacement batteries are also available through the Uniden Parts Department (See page 5).

B. Install the battery pack

Charge the battery pack for at least 15-20 hours before plugging the phone line into your phone.

- 1) Press in on the battery cover release and slide the cover down until it comes off.
- 2) Connect the battery pack connector observing correct polarity (black and red wires) to the jack inside the battery compartment.

Do not exert any force on this connection. It could cause damage to the battery or handset. The plastic connector will fit together only one way. Once you are certain that you have made a good connection, then insert the battery pack into the battery compartment. Do not pinch the wires.

- 3) Securely close the battery compartment cover by sliding it up until it snaps into place.
- 4) Place the handset in the base unit.

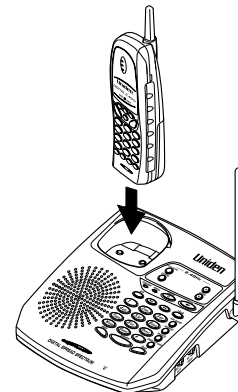
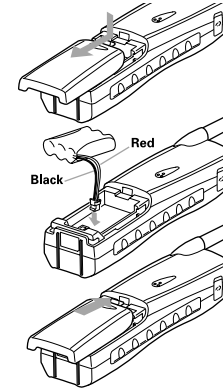



- Even when the battery pack is not being used, it will gradually discharge over a long period of time. For optimum performance, be sure to return the handset to the base unit after each telephone call.
- If you must replace the battery pack during a telephone call, complete the replacement of the battery pack within 30 seconds, and you can return to the original call.

Battery use time (per charge)

From fully charged

- Six hours continuous use.
- Ten days when the handset is in the standby mode.

Low battery alert

When the battery pack in the handset is low and needs to be charged, the *talk/batt* indicator flashes.

If this occurs while you are on the phone, you will hear an alert tone. Complete your call as quickly as possible and return the handset to the base for charging.

Cleaning the charging contacts

To maintain a good charge, it is important to clean the battery contacts on the handset and base unit with a dry cloth or a pencil eraser about once a month.

Do not use any liquids or solvents.

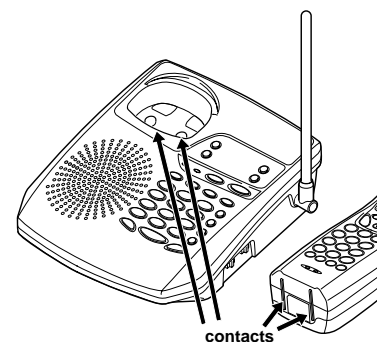
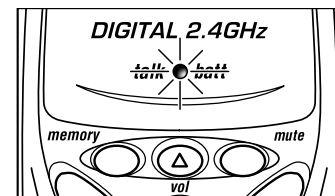

C. Connect the base unit

- 1) Connect the AC adapter to the **DC IN 9V** jack and a standard 120V AC wall outlet.
- 2) Set the base on a desk or tabletop. Place the handset on the base unit as shown.
- 3) Raise the antenna to a vertical position.

After installing the battery pack in the handset, **charge the handset at least 15-20 hours before plugging into the phone line.** Once the handset battery pack is fully charged, connect the telephone line cord to the base and the telephone wall outlet.

- 4) Connect the telephone line cord to the **TEL LINE** jack and to a telephone outlet.

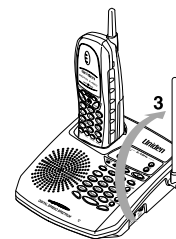
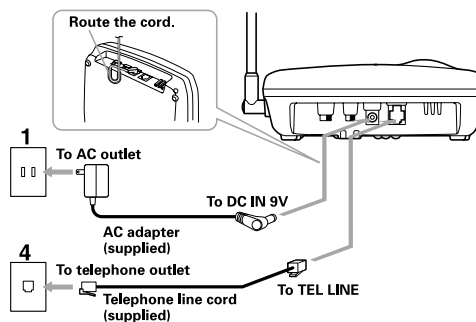

Modular



Place the power cord so that it does not create a trip hazard or where it could become chafed and create a fire or electrical hazard.

tip

- If your telephone outlet isn't modular, contact your telephone company for assistance.
- Use only the supplied AD-313 AC adapter. Do not use any other AC adapter.
- Connect the AC adapter to a continuous power supply.
- Place the base unit close to the AC outlet so that you can unplug the AC adapter easily.

D. Choose the dialing mode

Depending on your dialing system, set the PULSE-TONE switch as follows:

If your dialing system is	Set the switch to
Tone	<i>TONE</i>
Pulse	<i>PULSE</i>

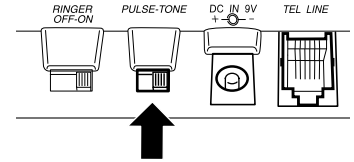

If you aren't sure of your dialing system, make a trial call with the PULSE-TONE switch set to ***TONE***.

If the call connects, leave the switch as is; otherwise, set to ***PULSE***.

Making and Receiving Calls

	Handset on the Base	Handset off the Base	From the Base
Answer a call	When the phone rings, remove the handset from the base. (AutoTalk)	Press any key.	Press speaker .
Make a call	<ol style="list-style-type: none">1. Remove the handset from the base and press talk.2. The talk/batt LED lights.3. Listen for the dial tone.4. Dial the number.	<ol style="list-style-type: none">1. Pick up the handset and press talk.2. The talk/batt LED lights.3. Listen for the dial tone.4. Dial the number.	<ol style="list-style-type: none">1. Press speaker.2. Dial the number.
Hang up	Return the handset to the base, (AutoStandby) or press talk .	Press talk .	Press speaker .
Redial	<ol style="list-style-type: none">1. Remove the handset from the base and press talk.2. Listen for the dial tone.3. Press redial to dial the last number dialed.	<ol style="list-style-type: none">1. Pick up the handset and press talk.2. Listen for the dial tone.3. Press redial to dial the last number dialed.	<ol style="list-style-type: none">1. Press speaker.2. Press redial.



The base microphone is located under the phone. Position yourself as near to the base as possible and speak clearly.

Terminology

Throughout this manual, terms such as Standby and Talk Mode are used. Below is the terminology explanation.

- **Standby Mode** - The handset is not in use, off the base and *talk* has not been pressed. A dial tone is not present.
- **Talk Mode** - The handset is off the base and *talk* has been pressed enabling a dial tone.

Adjusting Ringer/Volume Controls

Ringer tone and volume

1. While the phone is not in use, press *vol* ▲ or ▼.
2. The phone has two ringer tones, each with two volume levels.
Press *vol* ▲ or ▼ again until you hear the ringer tone and volume level you want.

Setting the handset earpiece volume

1. While you are on a call, press *vol* ▲ or ▼.
2. The phone has four receiver volume levels; Low, Medium, High, and Maximum.
Press *vol* ▲ or ▼ again until you hear the volume level you want. When you hang up, the phone keeps the last volume setting selected.

Base ringer switch

This switch turns the base ringer on or off.

Base speaker volume

To control the speaker volume of the base, adjust the volume by pressing *volume* ▲ or ▼ as desired.

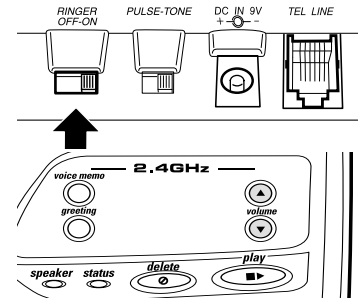

Tone Dialing Switch-over

Some telephone companies use equipment that require pulse dialing (sometimes referred to as rotary dialing). If you need to enter tone dialing digits, you can switch-over to tone dialing during the call. An example of this could be entering your bank account number after you have called your bank. The digits of your bank account can be entered using DTMF tones.

Initially make your call with the pulse dialing mode. Once your call connects, press ***** / **tone** on the handset, or ***** / **tone** on the base. Enter the desired number (like in example above the bank account number). These digits will be sent as tone dialing. This special number can be stored in a memory location. This is referred to as Chain Dialing (See page 20). Once the call ends, the tone mode is canceled and pulse dialing mode resumes.

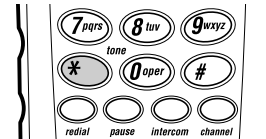

The tone feature only applies when the dial mode is set to pulse.

Traveling Out-of-Range

During a call, as you begin to move your handset too far from your base unit, noise increases. If you pass the range limits of the base unit, your call will terminate within 30 seconds.

Selecting a Different Channel

If you encounter interference while using your phone, you can manually change the phone's channel for clear operation. Interference can come from appliances or other phones in your home. This function works only when the phone is in use. The **channel** button on the handset allows you to choose between 35 factory set channels. During the course of a conversation, if you hear static or noise which makes it difficult to hear, press **channel**. The **talk/batt** LED flashes, indicating the phone is changing to another channel.

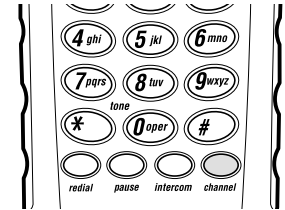

Using the Flash Button

Use the **flash** button for accessing services such as Call Waiting. (You must subscribe to Call Waiting service from your phone company to use this feature.) If you receive a call during your conversation, press the **flash** button on the handset or base. Press the **flash** button again to return to the previous call.

3-way Conferencing

The Uniden TRU3455 permits 3-way conversations between the handset, base and outside line.

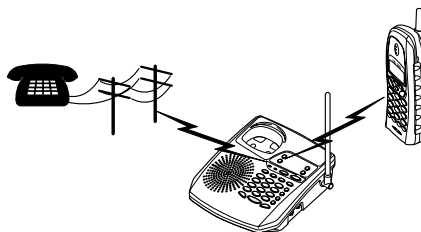

When speaking on the handset

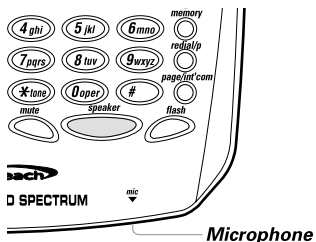

1. Press **speaker** on the base to join the 3-way conversation.
2. To hang up, press **speaker** on the base. The handset will still be connected to the call.

When speaking on the base

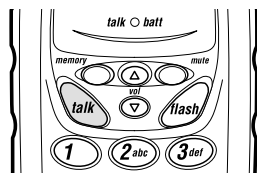

1. Press **talk** on the handset to join the 3-way conversation.
2. To hang up, return the handset to the base, or press **talk** on the handset. The base will still be connected to the call.



- Pressing the **speaker** key on the base while dialing with the handset will set the 3-way conversation mode, and dialing is not affected.
- Pressing the **talk** on the handset while dialing with the base will not set the 3-way conversation mode.
- During a 3-way conversation, you can only dial from the handset.



If the page is not answered within one minute, the paging sounds stops automatically.

Intercom Feature

Intercom from the base to handset

1. Press ***page/int'com*** on the base. The handset and the base beep. (If no answer, press ***page/int'com*** again to disconnect.)
2. Press ***intercom*** or ***talk*** on the handset to answer.
3. To turn off the intercom, press ***talk*** on the handset or ***speaker*** on the base.

Intercom from the handset to base

1. Press ***intercom*** on the handset. (If no answer, press ***intercom*** again to disconnect.)
2. At the base, press ***page/int'com*** or ***speaker*** to answer. Speak into the base microphone.
3. To turn off the intercom, press ***talk*** on the handset or ***speaker*** on the base.

Call Transfer Feature

To Transfer from the Handset to the Base

1. Press ***intercom*** on the handset. The caller is put on hold and the intercom tone sounds on the handset and base.
2. Press ***page/int'com*** or ***speaker*** on the base. The intercom mode is activated, but the caller is still on hold.
3. To transfer the call to the base, press ***talk*** on the handset. To cancel the transfer, press ***speaker*** on the base.

To Transfer from the Base to the Handset

1. Press ***page/int'com*** on the base. The caller is put on hold and the intercom tone sounds on the handset and base.
2. Press ***intercom*** or ***talk*** on the handset. The intercom mode is activated, but the caller is still on hold.
3. To transfer the call to the handset, press ***speaker*** on the base. To cancel the transfer, press ***talk*** on the handset.



- You have 20 seconds after pressing **memory** to enter the number you wish to store. Otherwise, an error tone will sound.
- The 10 memory locations in the base are independent locations from the handset.
- The 10 memory locations are represented by the numbers 0-9 on the keypad. If you store a number in one of locations, then attempt to store a different number in the same location later, the new number will overwrite the previous one.

Storing a Number in Memory

With the Handset

Your TRU3455 phone stores up to 10 numbers in the handset plus 10 numbers in the base.

1. Remove the handset from the base and press **memory**. The **talk/batt** LED blinks.
2. Enter the phone number you want to store (up to 20 digits).
3. Press **memory** and enter a number (0-9) on the keypad for the memory location you want to use. You hear a long beep and the **talk/batt** LED goes out indicating the number has been stored successfully.
If you select any keys other than 0-9, the handset will beep rapidly and no number will be stored.

With the Base

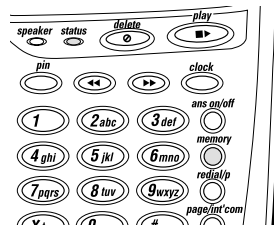

1. Press **memory**. The **status** LED blinks.
2. Dial the number you wish to store (up to 20 digits).
3. Press **memory**. Enter the memory location number (0-9) on the keypad. The **status** LED goes out. A confirmation tone sounds and the number is stored.

Entering a Pause in Memory Dialing

If you would like to use a phone number stored in memory to access voice mail, for example, you can store a pause in the phone number sequence.

To use this function, follow steps 1 and 2 in “Storing a Number in Memory”, then press the **pause** button on the handset or press **redial/p** on the base to place a pause in the phone number sequence. Each pause counts as one digit and represents a two second delay of time between the digits.

Follow the remaining steps in the “Storing a Number in Memory” section to complete the operation.

Storing Mixed Tone/Pulse Numbers

If your phone is set up for pulse dialing, you can store a mixed mode number (up to 20 digits) to easily access long distance services.

1. Remove the handset from the base and press **memory**, or press **memory** for the base.
2. Enter the number to be dialed in pulse mode.
3. Press *** / tone** or press *** / tone** on the base. The tone button counts as one digit and enters a pause.
4. Enter the number(s) to be dialed in tone mode.
5. Press **memory**, or press **memory** for the base and a number (0-9) on the keypad for the memory location you wish to use. You hear a long beep.



Remember, the phone number you wish to store cannot have more than 20 digits, including the pause. (The **pause** button counts as one digit.)



If you select a memory location that does not have a stored number, the handset or the base will beep rapidly and the phone will not dial.

Dialing a Stored Number

With the Handset

To dial a phone number stored in memory, press ***talk***, then press ***memory*** and enter the memory location (0-9). Your phone will dial the stored number.

With the Base

1. Press ***speaker***.
2. Press ***memory***. Enter the memory location number (0-9) to dial the number.

Chain Dialing

Each 10 memory locations on the handset and the base are not limited to phone number. You may want to store in memory a group of numbers (up to 20 digits) that you need to enter once your call connects. This is referred to as Chain Dialing.

An example of this is a bank account number. Once you have called your bank, when you are prompted to enter the account number, simply press ***memory*** and then the location where the special number has been stored.

Store your special number in memory as you would a phone number. (Refer to “Storing a Number in Memory” on page 18).

Enter a “pause” in the sequence as necessary. A “pause” counts as one digit and represents a two second delay in time between digits as they are sent.

Erasing a Stored Number

With the Handset

1. Remove the handset from the base.
2. Press **memory** twice.
3. Press the memory location number (0-9) you want to erase.
You hear a long beep confirming that you have erased the number.

With the Base

1. Press **memory** twice.
2. Enter the memory location number (0-9) of the number you wish to delete. The **status** LED goes out. A confirmation tone indicates the number has been erased.

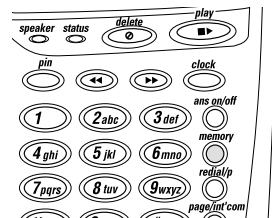

Mute

You can temporarily turn off the handset microphone or base microphone so that the person you are talking with cannot hear you. During a telephone call, press **mute** to turn off the microphone. To cancel mute, press **mute** again.

Replacing a Stored Number

Remember, your TRU3455 phone has 10 memory locations represented by the numbers 0-9 on the Handset or Base keypad. If you store a phone number in one of these locations, then attempt to store a different number in the same location later, the new number will replace the previous one.

Features

The TRU3455 has a built-in answering system that answers and records incoming calls.

You can also use your answering system to record a conversation, leave a voice memo message for others who use the phone, or to announce a special message to callers when you're away from your phone.

- Digital Tapeless Recording
- 13 minutes of Recording Time
- Selective Greetings (Outgoing Messages)
- Message Received Time and Day Announcement
- Remote Message Retrieval and Room Monitor
- Toll Saver
- Conversation Recording

Digital Tapeless Recording allows you to quickly review, save or delete the messages. You'll never have to worry about a tape wearing out, jamming, or resetting improperly.

The Integrated Answering System is easy and convenient to use, but please read through all of the instructions carefully.

Setting Up Your Answering System

Turning the answering system on/off

1. To turn the answering system on, press **ans on/off**. The current greeting message will be played and a tone will sound.
2. To turn the answering system off, press **ans on/off** again.



When the answering system is full, *FL* displays on the base and the system announces “No remaining time”. You should delete some messages so that the system can record new messages.

Setting the clock

The clock on TRU3455 Answering System starts when power is applied to the base. Follow these steps to set the clock to the correct time.

1. Press and hold **clock** until a tone sounds.
2. First, press **▶▶** or **◀◀** repeatedly until the correct day of the week is announced. (Number *0* through *6* displays on the base as each day is announced.) Press **clock** again to select the day.
3. Next, press **▶▶** or **◀◀** repeatedly until you hear the correct hour setting. Numbers *1* through *12* display on the base as each hour is announced. Press **clock** again to select the correct hour.
4. Press **▶▶** or **◀◀** repeatedly until you hear the correct minute setting. Numbers *0* through *59* display on the base as each minute is announced. Press **clock** again to select the correct minute.



- Press and hold **▶▶** or **◀◀** to quickly scroll through numbers on the display.
- If you don't complete the clock setting within two minutes, the system returns to standby.



- You can record a greeting up to 30 second.
- Position yourself as near to the base as possible and speak clearly when recording your outgoing message.

5. The LED displays *A* or *P*. Press **▶▶** or **◀◀** until you hear the correct AM/PM setting.
6. Press **clock** again to end the time/day setting. The TRU3455 announces the time that you have set.

Setting your greeting

When you receive a call, the answering system automatically plays either a preset message or your own greeting.

▼ *Preset Message*

The following message is prerecorded:

“Hello, no one is available to take your call. Please leave a message after the tone.”

▼ *Recording a personal outgoing message (Greeting)*

1. Press and hold **greeting** until you hear a tone. Start recording your message immediately after you hear the tone end.
2. When you finish recording your message, press **greeting** or **play ■▶**. A tone sounds and your message plays back on the phone.

▼ *Choosing between the two outgoing messages*

1. Press **greeting** to play the outgoing message.
2. Press **greeting** again while the message is played. This switches between the two options.

Selecting the message record time

You can set your answering system to record messages up to one or four minutes long.

One minute option: move the **REC TIME** switch to **1**.

Four minute option: move the **REC TIME** switch to **4**.

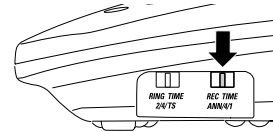

▼ *Announce only feature:*

The announce only feature plays an outgoing message, but it will not allow the caller to leave a message. Move the **REC TIME** switch to the **ANN** position.

The message counter LED displays "R" when the system is on standby.

The prerecorded outgoing message for Announce only feature is:

"Hello, no one is available to take your call." (twice)

Selecting a PIN code

To play your messages from a remote location, you will need to enter a two-digit Personal Identification Number (PIN) code (00-99). To select a PIN, perform the following steps.

1. On the base, press and hold **pin** until a tone sounds and the LED displays **00**.
2. To set the first number, press **▶▶** or **◀◀** repeatedly to scroll from 0 to 9. When the desired number appears in the display, press **pin**.
3. To set the second number, press **▶▶** or **◀◀** to scroll from 0 to 9. When the desired number appears in the display, press **pin**. Then the entered PIN code is announced.



Press and hold **▶▶** or **◀◀** to quickly scroll through numbers on the display.



- If you answer at another phone extension and the greeting has started, you cannot stop the message. Wait until your greeting is complete before starting your conversation.

- To stop playing your messages, press **play** ■▶ again.

Setting ring time switch

The ring time/toll saver switch allows you to set the number of rings the caller hears before the answering system plays your outgoing message. You can set the switch to answer after two rings or after four rings.

Once the greeting has started, you can stop it when you pick up the call at the handset or base.

In the **TS** (Toll Saver) position, the answering system picks up after two rings if you have new messages, and after four rings if there is none. This way, if you call long distance to check your messages, you can hang up after the third ring to avoid billing charges.

Using Your Answering System

Playing your messages

The base LED shows the number of total messages on the display. If the display is blinking, then there are new messages waiting for you. The TRU3455 is designed to play your new messages first. After you play your new messages you can then play your old messages.

1. Press **play** ■▶. The system announces the number of new and old messages, then the incoming messages are played.

When all new messages have played, a tone is heard.

2. After you have reviewed all your new messages, you can play your old messages again. Press **play** ■▶ and follow the instructions above.



- Pressing ◀◀ before 2 seconds (4 seconds from remote) of the message has played causes the system to scan back one message.
- If you have several messages, press and hold ◀◀ until you return to the message you want to replay.
- Each time ▶▶ is pressed, the system scans forward one message.
- If you have several messages, press and hold ▶▶ to find the message you want to play.
- When you press **delete**, you are permanently deleting the message. The message cannot be replayed.

Repeating a message

1. Press **play** ■▶ to review your message. The number of stored messages is announced.
2. After a message has played for a few seconds, press ◀◀ to repeat the message.
3. Press **play** ■▶ at any time to stop reviewing messages and return to standby. The message counter LED shows the total number of messages still on the system.

Skipping a message

1. Press **play** ■▶ to review your messages. The number of messages is announced.
2. Press ▶▶ at anytime to skip to the next message.
3. Press **play** ■▶ at any time to stop reviewing your messages and return to standby. The message counter LED shows the total number of messages on the system.

Deleting a message

▼ *Deleting individual message*

1. Press **play** ■▶ to review your message.
2. If you decide to delete a message, press **delete** anytime during the message. The system beeps and immediately goes to the next message.

▼ *Deleting all messages*

Press and hold **delete** while the system is in standby. A tone sounds when all messages are deleted. If there are any messages you have not reviewed, you can not delete all messages at once. An error tone occurs.



- The voice memo function is completely independent of the outgoing message. It's handy for leaving others a quick message.
- A voice memo message will be stored as a typical recorded message.
- Position yourself as near to the base as possible and speak clearly.
- A recorded conversation is stored and played back with typical recorded messages.

Voice memo

The voice memo function allows the user to record a message (up to 10 minutes) on the base.

1. Press and hold **voice memo** until you hear a tone. The message counter LED blinks.
2. Speak into the microphone.
3. When you have finished, press **voice memo** or **play** ■▶ to stop recording. The system returns to standby.
4. To play voice memo, press **play** ■▶.

Recording a conversation

You can record up to 10 minutes of conversation while you are making your call from the handset.

1. During the conversation from the handset, press and hold **voice memo** on the base. The unit begins recording and the LED blinks. Both parties can hear tones every 15 seconds.
2. To stop the recording, press **voice memo** or **play** ■▶.



You cannot record a conversation while you are speaking on the base.

Remote access away from home

You can operate your answering system from a remote location using any touch-tone telephone. Use this function to check for recorded messages, to play or delete messages, to record a new outgoing message, and to monitor sounds in the room.

1. Call your telephone number.
2. While the greeting message is played, press # and your PIN code within 2 seconds.
If the answering system is off, let it ring 10 times. The tone sounds. Then, press # and your PIN code within 2 seconds.
3. The answering system announces the time and day and the number of messages stored in memory. Then the message playback automatically begins.
4. You may continue to listen to your message, or you may select a command from the following chart.

Command	Function
# then 1	Repeat a message
# then 2	Playing your messages
# then 3	Skipping a message
# then 4	Deleting a message
# then 5	Stop message playback
# then 6	Answering system on
# then 7	Voice memo record/stop (up to 4 minutes recording time)
# then 8	Greeting message record/stop
# then 9	Answer system off
# then *	Room monitor

5. After all of your messages have played, or the playback time exceeds 4 minutes, you will hear intermittent beeps indicating that the system is in the command waiting mode. You may enter another command at this time from the chart above.
6. When you finish, hang up to exit the system.
The answering system automatically returns to standby.



- During the remote operation, r[] displays on the base.
- You must enter a command within 15 seconds when entering command waiting mode is started otherwise the answering system automatically hangs up and returns to standby.
- The system will only playback messages for four minutes and then it returns to command waiting mode. To continue playing your message, press # then 2 again within 15 seconds.



If you enter an incorrect PIN code three times, an error tone sounds and the phone automatically hangs up.

Remote room monitor

You can call your answering system from any touch-tone phone and monitor sounds in the room where your base is installed.

1. Call your telephone number.
2. While the greeting message is played, press **#** and your PIN code.
3. The answering system begins announcing the time and day.
4. Press **#** then **5** to stop the messages.
5. Press **#** then *****. You hear sounds in the room where your phone is installed. After 15 seconds, the answering system returns to the command waiting mode.
6. Press **#** then ***** to monitor the room for another 15 seconds. Or select another remote function. Or hang up to exit the system. The answering system automatically returns to standby.

Turn on the answering machine remotely

If you have forgotten to turn on your answering machine, you can turn it on remotely from any touch-tone telephone.

1. Call your telephone number.
2. Wait ten rings until the machine answers.
3. Press **#** and enter your PIN code within 2 seconds. The answering system begins to announce the time and day.
4. Press **#** then **6** to turn the answering system on.
5. Hang up the phone and subsequent calls will be answered by the machine.

Changing the Digital Security Code

The digital security code is an identification code used to connect the handset and the base unit. Normally, setting the code is not necessary.

The first time you charge your handset, the security code is automatically set. (See page 4.)

In the rare situation that you suspect another cordless telephone is using the same security code, you can change the code.

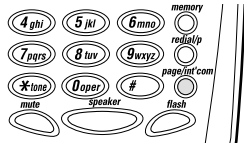

1. Remove the handset from the base unit.
Press and hold **page/int'com** on the base for 3 seconds.
2. While the handset is emitting the paging sound, replace the handset to the base unit. The paging tone stops.
Leave the handset on the base for more than 3 seconds. A random, new security code is set.



If the handset battery pack is completely discharged or the battery pack is removed, the digital security code will be lost. If this happens, a new security code is set automatically next time the battery pack is charged.

Installing the Beltclip

To Attach the Beltclip

Insert the beltclip into the holes on each side of the handset. Press down until it clicks.

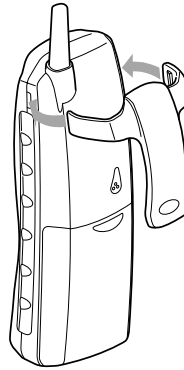

To Remove the Beltclip

Pull both sides of the beltclip to release the tabs from the holes.

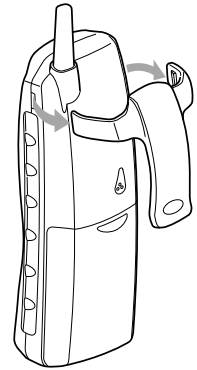

Headset Installation

Your phone may be used with an optional headset, the Uniden HS910. To use this feature, simply plug the headset plug into the headset jack on the handset. Your phone is ready for hands-free conversation. (Headsets may be purchased by calling the Uniden Parts Department or visiting the web site. See page 5.)

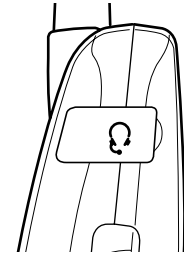

Note on Power Sources

Battery replacement and handling

When the operating time becomes short, even after a battery is recharged, please replace the battery.

With normal usage, your battery should last about one year.

Please contact your place of purchase or the Uniden Parts Department for a replacement battery.

Power Failure

During the period that the power is off, you will not be able to make or receive calls with the telephone.

RECYCLING NICKEL-CADMIUM BATTERIES



**NICKEL-CADMIUM BATTERIES
MUST BE DISPOSED OF
PROPERLY.**

Nickel-cadmium cells are used in the battery pack. Please take your used nickel-cadmium battery packs to a store that recycles nickel-cadmium batteries.

Caution

- Use the specified battery pack.
- Do not remove the battery from the handset to charge it.
- Never throw the battery into a fire, disassemble it, or heat it.
- Do not remove or damage the battery casing.

Maintenance

When slightly dirty

Wipe with a soft, dry cloth.

When very dirty

Wipe with a soft cloth that has been dampened with diluted, neutral detergent. Dry with a dry cloth.

When the charging terminals become dirty

Wipe with a dry cloth or a pencil eraser, if necessary.

Caution

Do not use paint thinner, benzene, alcohol, or other chemical products. Doing so may discolor the surface of the telephone and damage the finish.

Troubleshooting

If your TRU3455 cordless telephone is not performing to your expectations, please try these simple steps. If you are still unable to resolve the problems, contact your place of purchase or call customer service at (800) 297-1023.

Caution: Do not attempt to service this unit yourself. Servicing must be performed by qualified personnel.

Problem	Suggestion
The <i>status</i> LED won't come on when handset is placed in base	<ul style="list-style-type: none">• Make sure the AC adapter is plugged into the base and wall outlet.• Make sure the handset is properly seated in the base.• Make sure the rechargeable battery pack is properly connected in the handset.• Make sure that the charging contacts on the handset and on the base are clean.
The audio sounds weak and/or scratchy	<ul style="list-style-type: none">• Make sure that the base antenna is in the vertical position.• Interference may be caused by other electronic equipment such as TVs, computers, microwave ovens, etc.• You may have gone too far from the base.• Press <i>channel</i> to help eliminate background noise.
Can't make or receive calls	<ul style="list-style-type: none">• Check both ends of the telephone line cord.• Make sure the AC adapter is plugged into the base and a wall outlet.• Disconnect the AC adapter for a few minutes, then reconnect it.• Reset the digital security code (See page 31).• Make sure <i>talk</i> or <i>speaker</i> is pressed.
Handset doesn't ring or receive a page	<ul style="list-style-type: none">• The nickel-cadmium battery pack may be weak.• Charge the battery for 15-20 hours.• The handset may be too far away from the base.• Place the base away from appliances or metal objects.• Reset the digital security code (See page 31).
Severe noise interference	<ul style="list-style-type: none">• Keep the handset away from microwave ovens, computers, remote control toys, wireless microphones, alarm systems, intercoms, room monitors, fluorescent lights, and electrical appliances.• Move to another location or turn off the source of interference.

Symptom	Suggestion
The answering system does not work.	<ul style="list-style-type: none"> • Make sure the base unit is plugged in. • Make sure that the answering system is turned on. • Make sure that the message record time is not set to ANN (See page 25).
Messages are incomplete.	<ul style="list-style-type: none"> • The incoming messages may be too long. Remind callers to leave a brief message. • The memory may be full. Delete some or all of the saved messages.
After a power failure, the outgoing message is deleted.	<ul style="list-style-type: none"> • Record your greeting again. The preset messages should remain.
No sounds on the base unit speaker during call monitoring or message playback.	<ul style="list-style-type: none"> • Adjust the speaker volume on the base unit.
Cannot access remote call-in features from another touch-tone phone.	<ul style="list-style-type: none"> • Make sure you are using the correct PIN number. • Make sure that the touch-tone phone you're using can transmit the tone for at least two seconds. If it cannot, you may have to use another phone to access your message.

General Information

The TRU3455 complies with FCC Parts 15 and 68.
Operating Temperature: 0°C to +50°C (+32°F to +122°F)

AC Adapter Information

AC Adapter part number: AD-313
Input Voltage: 120V AC 60Hz
Output Voltage: 9V DC 400 mA

Battery Information

Battery part number: BT-800
Capacity: 800 mAh, 3.6V
Battery Use Time (per charge)
From fully charged:
Talk Mode duration 6 hours
Standby Mode duration 10 days



If the handset is left off of the base, the actual Talk Mode duration will be reduced respective to the amount of time the handset is off the base.

Recharge your phone on a regular basis about once a week by placing the handset on the base for 15 hours. When the operating time becomes short, even after the battery is recharged, please replace the battery. With normal usage, the battery should last about one year.

Replacement batteries may be purchased at your local Uniden dealer or by contacting the Uniden Parts Department (800) 554-3988. Hours are from 7:00 a.m. to 5:00 p.m. Central Time, Monday through Friday. We can also be reached on the web at www.uniden.com

Specifications, features, and availability of optional accessories are all subject to change without prior notice.

Precautions!

Before you read anything else, please observe the following:

Warning!

Uniden America Corporation DOES NOT represent this unit to be waterproof. To reduce the risk of fire, electrical shock, or damage to the unit, DO NOT expose this unit to rain or moisture.

Rechargeable Nickel-Cadmium Battery Warning

- This equipment contains a rechargeable nickel-cadmium battery.
- Cadmium is a chemical known to the State of California to cause cancer.
- The rechargeable nickel-cadmium battery contained in this equipment may explode if disposed of in a fire.
- **Do not** short-circuit the battery.
- Do not charge the rechargeable nickel-cadmium battery used in this equipment in any charger other than the one designed to charge this battery as specified in the owner's manual. Using another charger may damage the battery or cause the battery to explode.

Rechargeable Nickel-Cadmium Batteries Must Be Recycled or Disposed of Properly



- Uniden voluntarily participates in an RBRC[®] industry program to collect and recycle nickel-cadmium batteries at the end of their useful life, when taken out of service within the United States. The RBRC[®] program provides a convenient alternative to placing used nickel-cadmium batteries into the trash or municipal waste stream, which is illegal in some areas.
- Through the RBRC[®] program, Uniden makes it easy for you to drop off the used battery at local retailers of replacement nickel-cadmium batteries. You may also contact your local recycling center for information on where to return the used battery. Please call 1-800-8-BATTERY for information on Ni-Cd battery recycling in your area. Uniden's involvement in this program is part of its commitment to protecting our environment and conserving natural resources.
- RBRC[®] is a registered trademark of the Rechargeable Battery Recycling Corporation.



The exclamation point within an equilateral triangle is intended to alert the user to the presence of important operating and maintenance (servicing) instructions in the literature accompanying the appliance.

Important Safety Instructions

When using your telephone equipment, these basic safety precautions should always be followed to reduce the risk of fire, electrical shock, and injury to persons:

1. Read and understand all instructions.
2. Follow all warnings and instructions marked on the product.
3. Unplug this product from the wall outlet before cleaning. Use a dry cloth for cleaning without liquid or aerosol cleaners.
4. Do not use this product near water; for example, near a bath tub, wash bowl, kitchen sink or laundry tub, in a wet basement, or near a swimming pool.
5. Do not place this product on an unstable cart, stand, or table. The telephone may fall, causing serious damage to the unit.
6. Slots and openings in the cabinet and the back or bottom are provided for ventilation. To protect the product from overheating, these openings must not be blocked or covered. This product should never be placed near or over a radiator or heat register. This product should not be placed in a built-in installation unless proper ventilation is provided.
7. This product should be operated only from the type of power source indicated on the marking label. If you are not sure of the type of power supply to your home, consult your dealer or local power company.
8. Do not allow anything to rest on the power cord. Do not locate this product where the cord will be damaged by persons walking on it.
9. Do not overload wall outlets and extension cords, as this can result in the risk of fire or electrical shock.
10. Never push objects of any kind into this product through cabinet slots, as they may touch dangerous voltage points or short out parts that could result in a risk of fire or electric shock. Never spill liquid of any kind on the product.
11. To reduce the risk of electric shock, do not disassemble this product. Take it to qualified service personnel when service or repair work is required. Opening or removing covers may expose you to dangerous voltages or other risks. Incorrect reassembly can cause electric shock when the appliance is subsequently used.
12. Unplug this product from the wall outlet and refer servicing to qualified service personnel under the following conditions:
 - A. When the power supply cord is damaged or frayed.
 - B. If liquid has been spilled into the product.
 - C. If the product has been exposed to rain or water.
 - D. If the product does not operate normally when following the operating instructions. (Adjust only those controls that are covered by the operating instructions. Improper adjustment of other controls may result in damage and will often require extensive repair work by a qualified technician.)
 - E. If the product has been dropped or the cabinet has been damaged.
 - F. If the product exhibits a distinct change in performance.
13. Do not use the telephone to report a gas leak in the vicinity of the leak.

Additional Battery Safety Precautions

Caution! To reduce the risk of fire or injury to persons by the battery, read and follow these instructions:

1. Use only the appropriate type and size battery pack specified in the owner's manual.
2. Do not dispose of the battery pack in a fire. The cell may explode. Check the nickel-cadmium battery disposal package insert for disposal instructions.
3. Do not open or mutilate the battery pack. Released electrolyte is corrosive and may cause damage to the eyes or skin. It may be toxic if swallowed.
4. Exercise care in handling the battery in order not to short the battery with conducting materials such as rings, bracelets, and keys. The battery or conductor may overheat and cause burns.
5. Charge the battery pack provided with or identified for use with this product only in accordance with the instructions and limitations specified in the owner's manual provided for this product.
6. Observe proper polarity orientation between the battery pack and battery charger.

SAVE THESE INSTRUCTIONS!

Important Electrical Considerations

Unplug all electrical appliances when you know an electrical storm is approaching. Lightning can pass through your household wiring and damage any device connected to it. This phone is no exception.

Warning!

Please do not attempt to unplug any appliance during an electrical storm.

The FCC Wants You To Know

Changes or modifications to this product not expressly approved by Uniden, or operation of this product in any way other than as detailed by the owner's manual, could void your authority to operate this product. The equipment cannot be used on public coin phone service provided by the telephone company. Connection to party line service is subject to state tariffs. (Contact the state public utility commission, public service commissioner or corporation commission for information.)

Range

Your new phone is designed to achieve the maximum possible range by transmitting and receiving according to the highest specifications set forth by the FCC. We have rated this phone to operate at a maximum distance with the qualification that the range depends upon the environment in which the telephone is used. Many factors limit range, and it would be impossible to include all the variables in our rating. The Maximum Range rating of this phone is meant to be used as a means of comparison against other range claims.

Telephone Line Problems

The FCC has granted the telephone company the right to disconnect service in the event that your phone causes problems on the telephone line. Also, the telephone company may make changes in facilities and services which may affect the operation of your unit. However, your telephone company must give adequate notice in writing prior to such actions to allow you time for making necessary arrangements to continue uninterrupted service.

If you are having trouble with your telephone service, you must first disconnect your phone to determine if it is the cause of your problem. If you determine that it is the cause, you must leave it disconnected until the trouble has been corrected.

Radio Interference

Radio interference may occasionally cause buzzing and humming in your cordless handset, or clicking noises in the base. This interference is caused by external sources such as TV, refrigerator, vacuum cleaner, fluorescent lighting, or electrical storm. Your unit is NOT DEFECTIVE. If these noises continue and are too distracting, please check around your home to see what appliances may be causing the problem. In addition, we recommend that the base not be plugged into a circuit that also powers a major appliance because of the potential for interference. Be certain that the antenna on the unit is fully extended when needed.

In the unlikely event that you consistently hear other voices or distracting transmissions on your phone, you may be receiving radio signals from another cordless telephone or other source of interference. If you cannot eliminate this type of interference, you need to change to a different channel.

Finally, it should be noted that some cordless telephones operate at frequencies that may cause interference to nearby TVs and VCRs. To minimize or prevent such interference, the base of the cordless telephone should not be placed near or on top of a TV or VCR. If interference is experienced, moving the cordless telephone farther away from the TV or VCR will often reduce or eliminate the interference.

More Than One Cordless Telephone

If you want to use more than one cordless telephone in your home, they must operate on different channels. Press the channel key to select a channel that provides the clearest communication.

Cordless Telephone Privacy

Cordless telephones are radio devices. Communications between the handset and base of your cordless telephone are accomplished by means of radio waves which are broadcast over the open airways. Because of the inherent physical properties of radio waves, your communications can be received by radio receiving devices other than your own cordless telephone unit. Consequently, any communications using your cordless telephone may not be private.

Installation Considerations

Selecting a Location

Before choosing a location for your new phone, there are some important guidelines you should consider:

- The location should be close to both a phone jack and continuous power outlet. (A continuous power outlet is an AC outlet which does not have a switch to interrupt its power.)
- Keep the base and handset away from sources of electrical noise such as motors or fluorescent lighting.
- Be sure there is sufficient space to fully extend the base antenna.
- The base can be placed on a desk or tabletop or mounted on a standard telephone wall plate.
- You should charge your new phone for 15-20 hours before completing the installation or using the handset.

Telephone Line Outlets

There are two types of phone outlets:

Modular Jack

Most phone equipment available now uses modular jacks. Phone cords are fitted with a molded plastic connector which plugs into this type of jack. If you do not have modular phone jacks, contact your local telephone company for information about their installation.

Hardwired Jack

Some equipment is wired directly to a phone jack, and these types of installations require a modular jack converter. This type of installation is not difficult; however, you should contact your Uniden telephone dealer or a telephone supply store for advice about the proper adapter or converter for your particular situation.

Connecting the Telephone Cords

Consider these safety guidelines before connecting the telephone cords:

Caution!

- Never install telephone wiring during a lightning storm.
- Never touch uninsulated telephone wires or terminals unless the telephone line has been disconnected.
- Use caution when installing or modifying telephone lines.

Applying Power to the Base

This phone requires an AC outlet, without a switch to interrupt power, and the included AC adapter. To relieve strain on the DC plug when the phone is placed on a desk or table, wrap the power cord around the strain relief notch on the bottom of the base.

NOTE: Place the power cord so that it does not create a trip hazard, or where it could become chafed and create a fire or other electrical hazards.

Adapter Safety Features

If the AC adapter furnished with this phone has a polarized line plug (a plug having one blade wider than the other), this plug will fit into the power outlet only one way. If you are unable to insert the plug fully into the outlet, try reversing the plug.

Do not alter the shape of the blades of the polarized plug!

NOTE: If you cannot plug the AC adapter into the outlet, contact someone about replacing the outlet.

Plug the AC Adapter into a standard 120 VAC wall outlet.

Do not use an outlet controlled by a wall switch.



Use only the Uniden AC Adapter supplied with this phone.

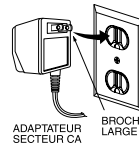

One Year Limited Warranty

Important: Evidence of original purchase is required for warranty service.

WARRANTOR: UNIDEN AMERICA CORPORATION ("Uniden")

ELEMENTS OF WARRANTY: Uniden warrants, for one year, to the original retail owner, this Uniden Product to be free from defects in materials and craftsmanship with only the limitations or exclusions set out below.

WARRANTY DURATION: This warranty to the original user shall terminate and be of no further effect 12 months after the date of original retail sale. The warranty is invalid if the Product is (A) damaged or not maintained as reasonable or necessary, (B) modified, altered, or used as part of any conversion kits, subassemblies, or any configurations not sold by Uniden, (C) improperly installed, (D) serviced or repaired by someone other than an authorized Uniden service center for a defect or malfunction covered by this warranty, (E) used in any conjunction with equipment or parts or as part of any system not manufactured by Uniden, or (F) installed or programmed by anyone other than as detailed by the owner's manual for this product.

STATEMENT OF REMEDY: In the event that the product does not conform to this warranty at any time while this warranty is in effect, warrantor will either, at its option, repair or replace the defective unit and return it to you without charge for parts, service, or any other cost (except shipping and handling) incurred by warrantor or its representatives in connection with the performance of this warranty. Warrantor, at its option, may replace the unit with a new or refurbished unit. THE LIMITED WARRANTY SET FORTH ABOVE IS THE SOLE AND ENTIRE WARRANTY PERTAINING TO THE PRODUCT AND IS IN LIEU OF AND EXCLUDES ALL OTHER WARRANTIES OF ANY NATURE WHATSOEVER, WHETHER EXPRESS, IMPLIED OR ARISING BY OPERATION OF LAW, INCLUDING, BUT NOT LIMITED TO ANY IMPLIED WARRANTIES OF MERCHANTABILITY OR FITNESS FOR A PARTICULAR PURPOSE. THIS WARRANTY DOES NOT COVER OR PROVIDE FOR THE REIMBURSEMENT OR PAYMENT OF INCIDENTAL OR CONSEQUENTIAL DAMAGES. Some states do not allow this exclusion or limitation of incidental or consequential damages so the above limitation or exclusion may not apply to you.

LEGAL REMEDIES: This warranty gives you specific legal rights, and you may also have other rights which vary from state to state. This warranty is void outside the United States of America.

PROCEDURE FOR OBTAINING PERFORMANCE OF WARRANTY: If, after following the instructions in the owner's manual you are certain that the Product is defective, pack the Product carefully (preferably in its original packaging). The Product should include all parts and accessories originally packaged with the Product. Include evidence of original purchase and a note describing the defect that has caused you to return it. The Product should be shipped freight prepaid, by traceable means, to warrantor at:

Uniden America Corporation
Parts and Service Division
4700 Amon Carter Blvd.
Fort Worth, TX 76155

(800) 297-1023, 7 a.m. to 7 p.m. Central, Monday through Friday

Index

0 - 9

3-way conferencing 15

A

Adjusting the volume 12

Answering device

 Features 22

 Setting up 23

 Using 26

B

Base ringer switch 12

Base speaker volume 12

Battery pack

 Preparing and charging 7

C

Connection 9

D

Dialing mode 10

Digital security code 4, 31

E, F, G

Earpiece volume 12

H

Headset installation 32

I, J, K, L

Installing the beltclip 32

Intercom 16

M, N, O

Maintenance 33

Making a call 11

Memory dialing

 Dialing a stored number 20

 Erasing a stored number 21

 Storing phone numbers 18

Mute 21

P, Q

Package contents 5

R

Receiving a call 11

Redialing a call 11

Ringer volume 12

S

Setting up the base unit 6

Setting up the handset 7

Setting up your

answering system

 Selecting a PIN code 25

 Selecting the

 message record time 25

 Setting ring time switch 26

 Setting the clock 23

 Setting your greeting 24

 Turning the answering

 system on/off 23

T

Transferring a call 17

Troubleshooting 34

U, V, W, X, Y, Z

Using your answering system

 Deleting a message 27

 Playing your messages 26

 Recording a conversation 28

 Remote access

 away from home 28

 Remote room monitor 30

 Repeating a message 27

 Skipping a message 27

 Voice memo 28

Memo

At Uniden, we'll take care of you!

If you need any assistance with this product, please call our Customer Hotline at

1-800-297-1023

PLEASE DO NOT RETURN THIS PRODUCT TO THE PLACE OF PURCHASE.

Our Uniden representatives will be happy to help you with any matters regarding the operation of this unit, available accessories, or any other related matters.

Thank you for purchasing a Uniden product.

Hours: M-F 7:00 AM to 7:00 PM CST.

THANK YOU FOR PURCHASING A UNIDEN CORDLESS PHONE

A World Without Wires | **Uniden**[®]

Covered under one or more of the following U.S. patents:

4,511,761	4,523,058	4,595,795	4,797,916	5,381,460	5,426,690
5,434,905	5,491,745	5,533,010	5,574,727	5,650,790	5,660,269
5,661,780	5,663,981	5,671,248	5,717,312	5,754,407	5,768,345
5,787,356	5,838,721	5,864,619	5,893,034	5,912,968	5,915,227
5,929,598	5,930,720	5,960,358	5,987,330		

© 2001 Uniden America Corporation, Fort Worth, TX
All rights reserved.

Printed in China
UCZZ01760BZ